

Seminários de Inovação

CIÊNCIA & ARTE

A experiência dos 'robots-pintores'

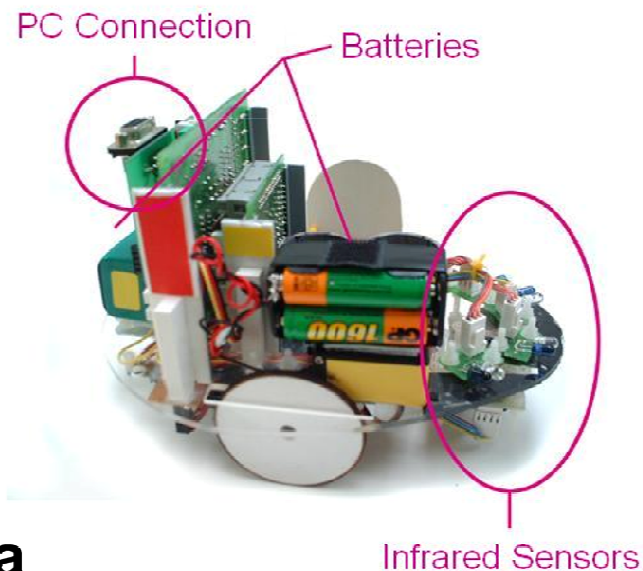

**Henrique
Garcia Pereira**

**IST, 8 de Maio
de 2007**





Génie Chimique

TURNER (1844) - Rain, Steam and Speed
Great Western Railway

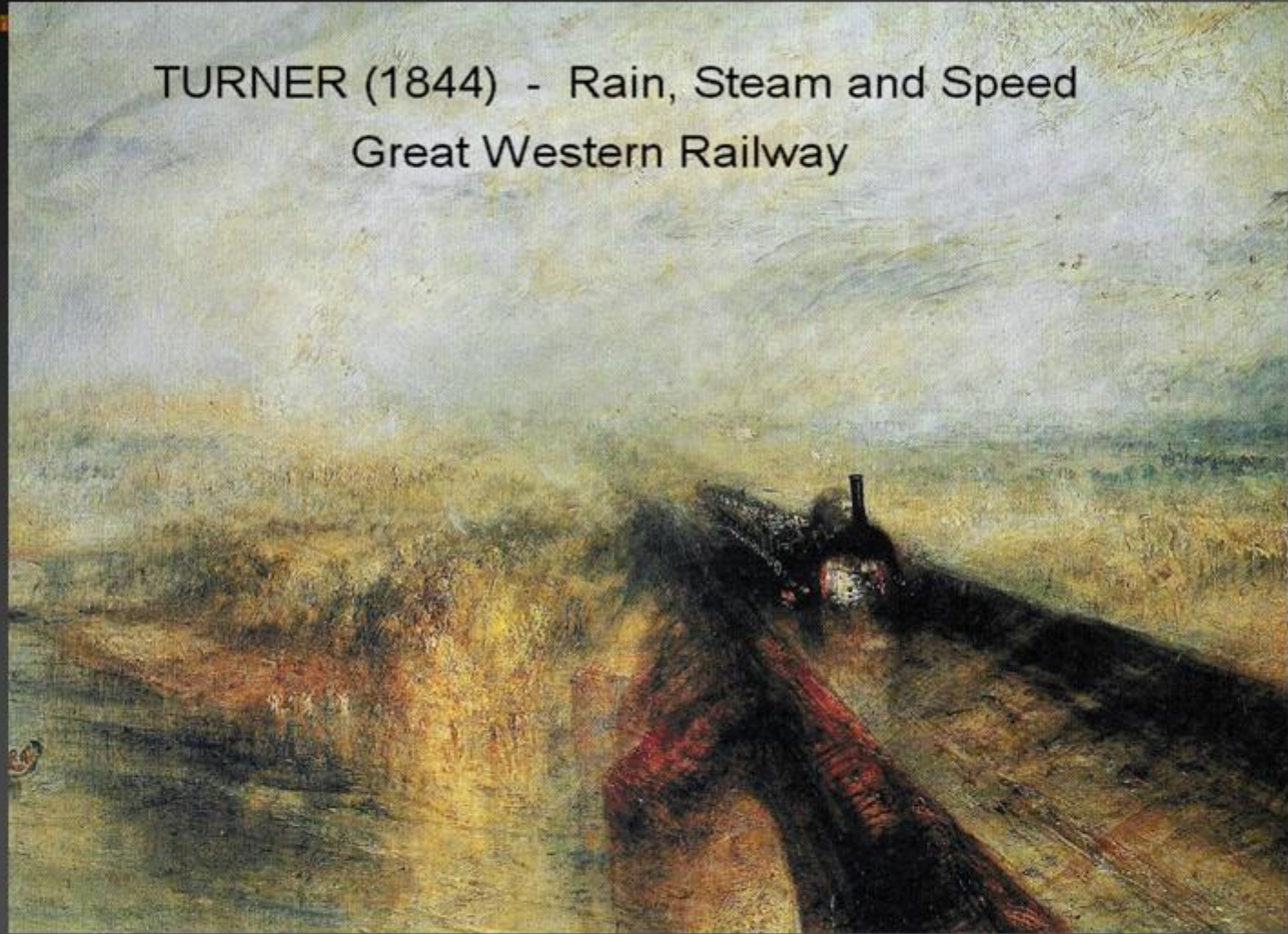

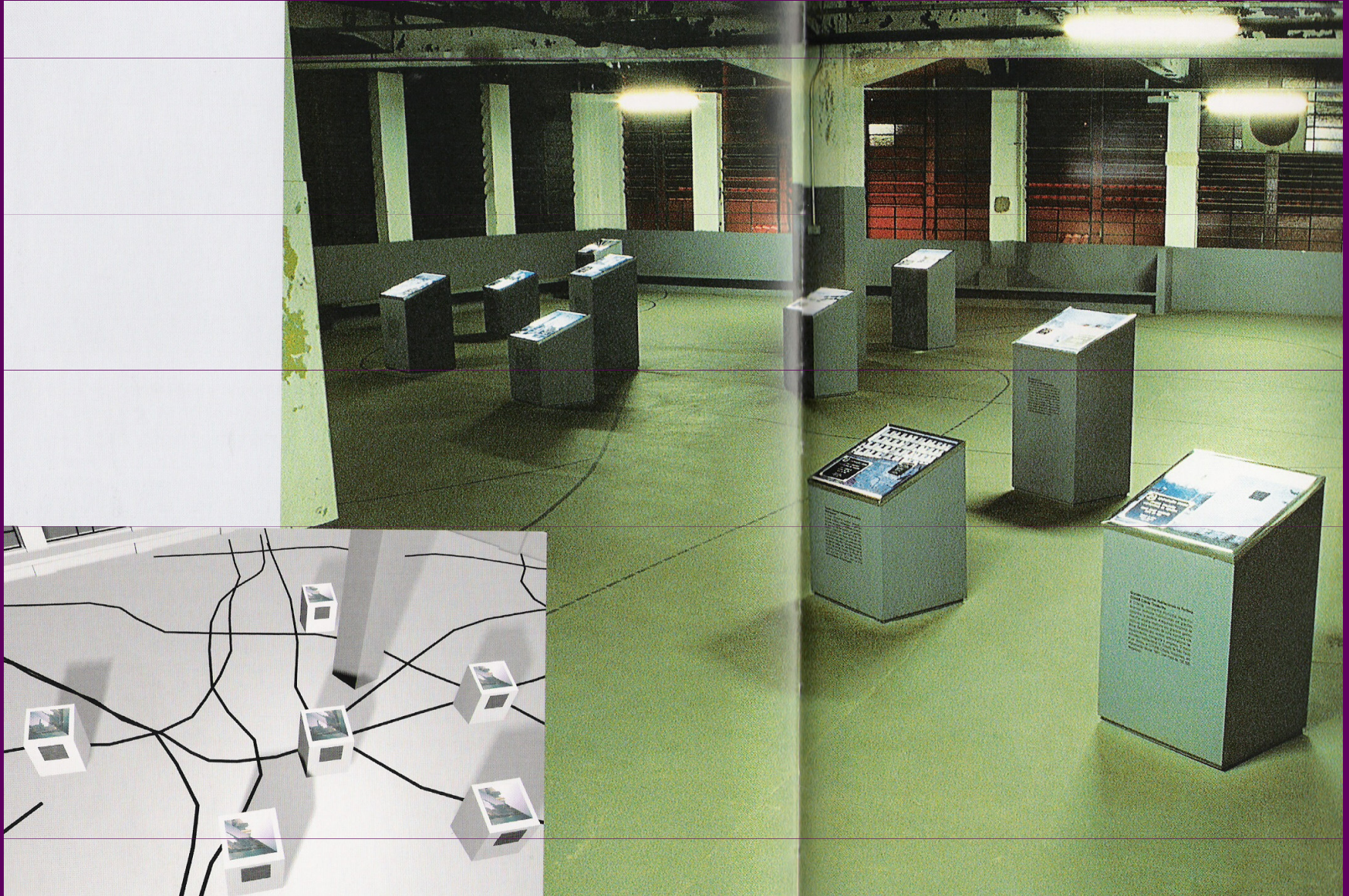



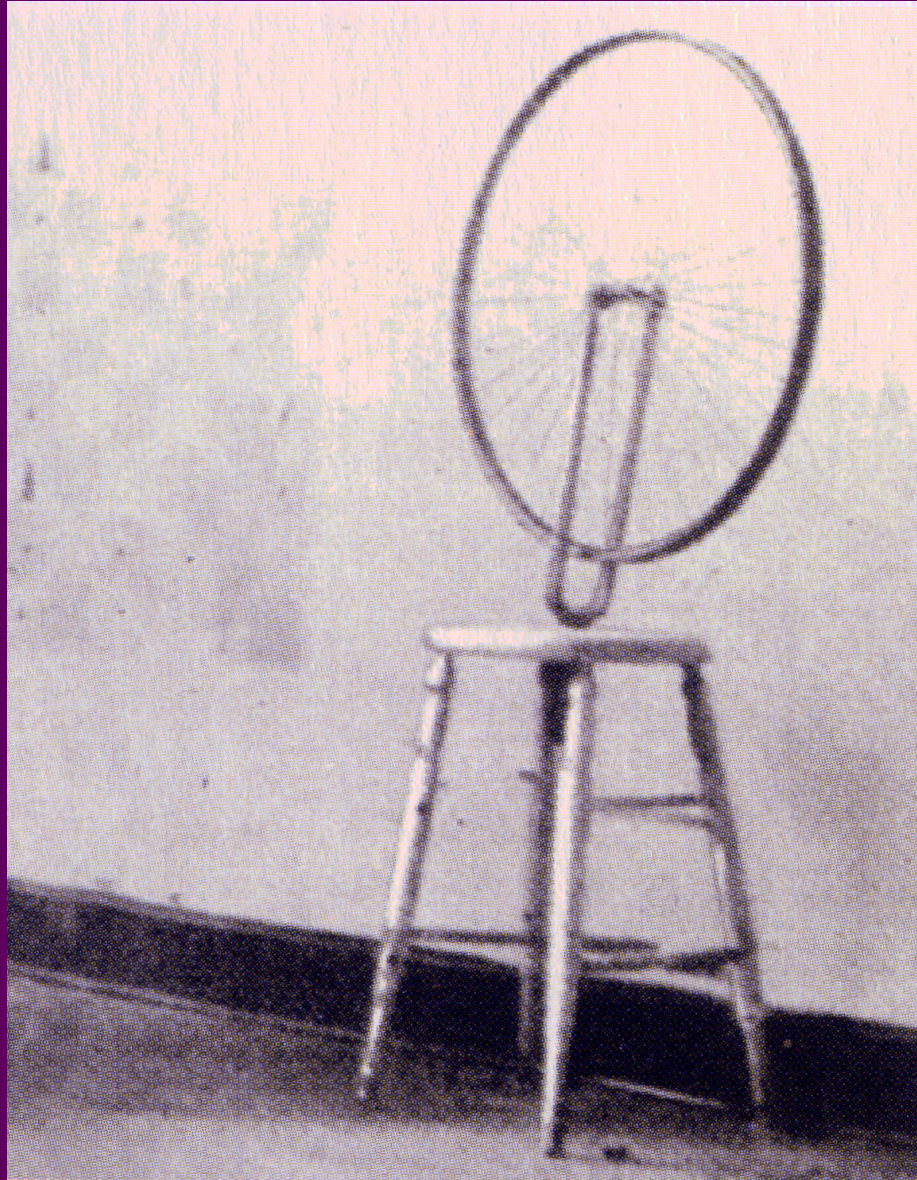

SATISFICING solution in Herbert Simon terms

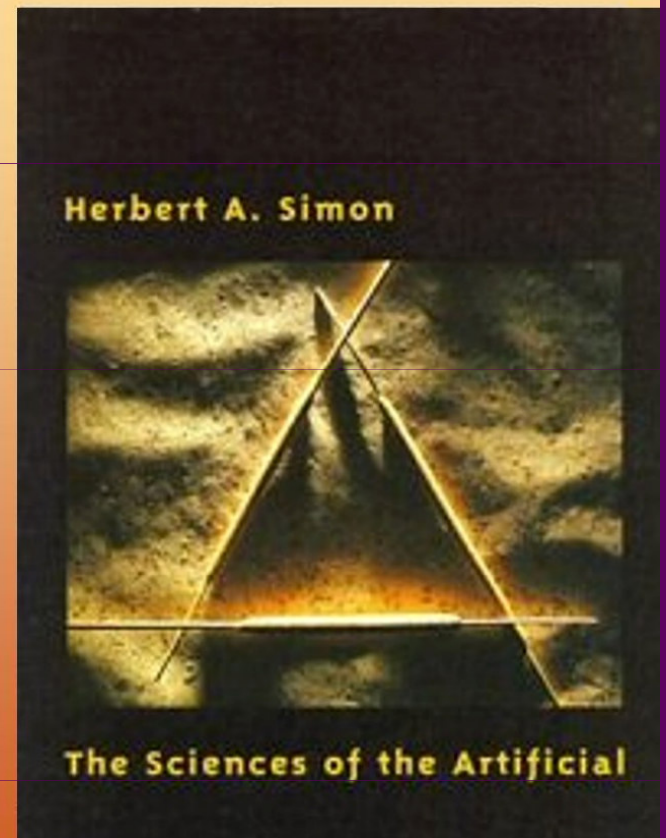
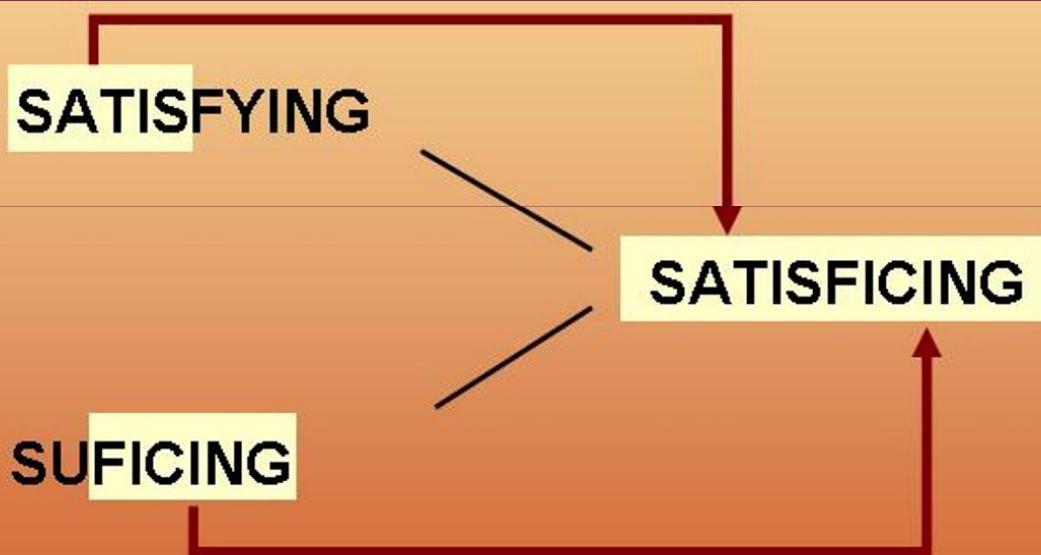



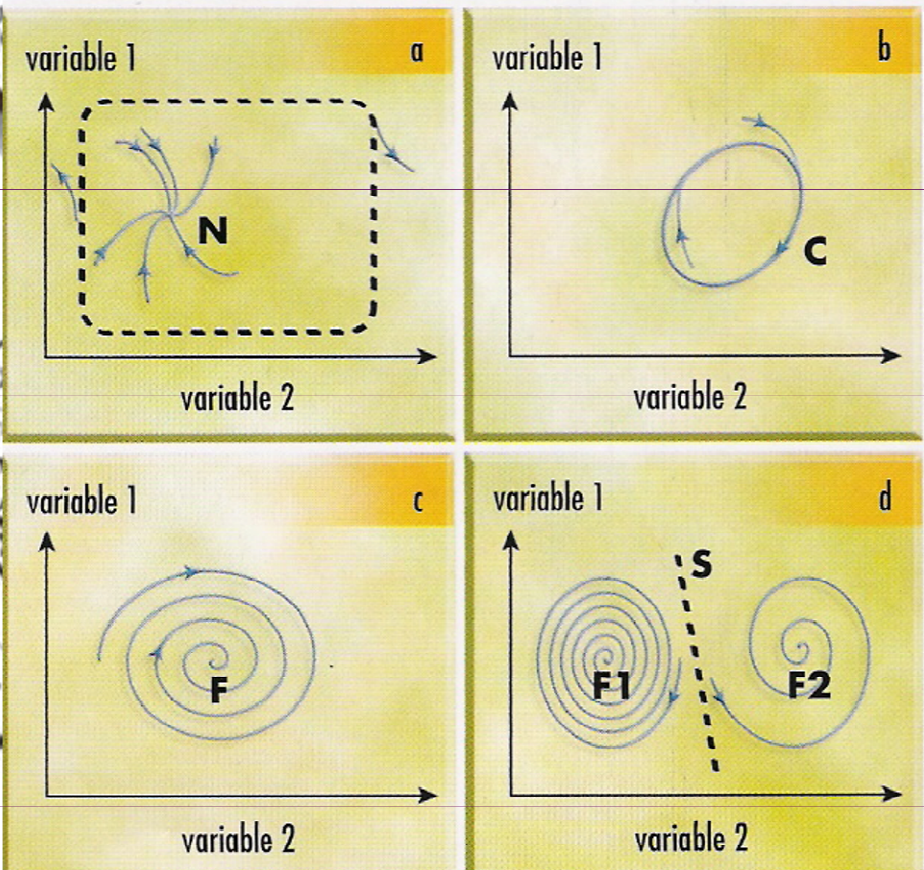
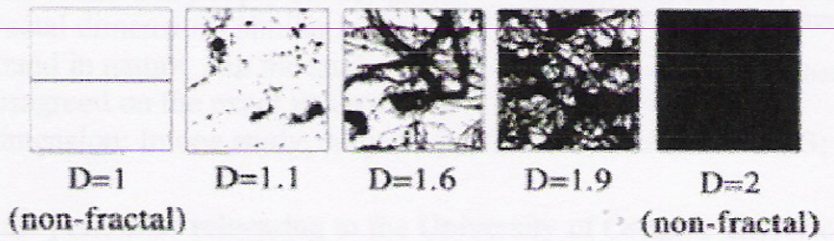
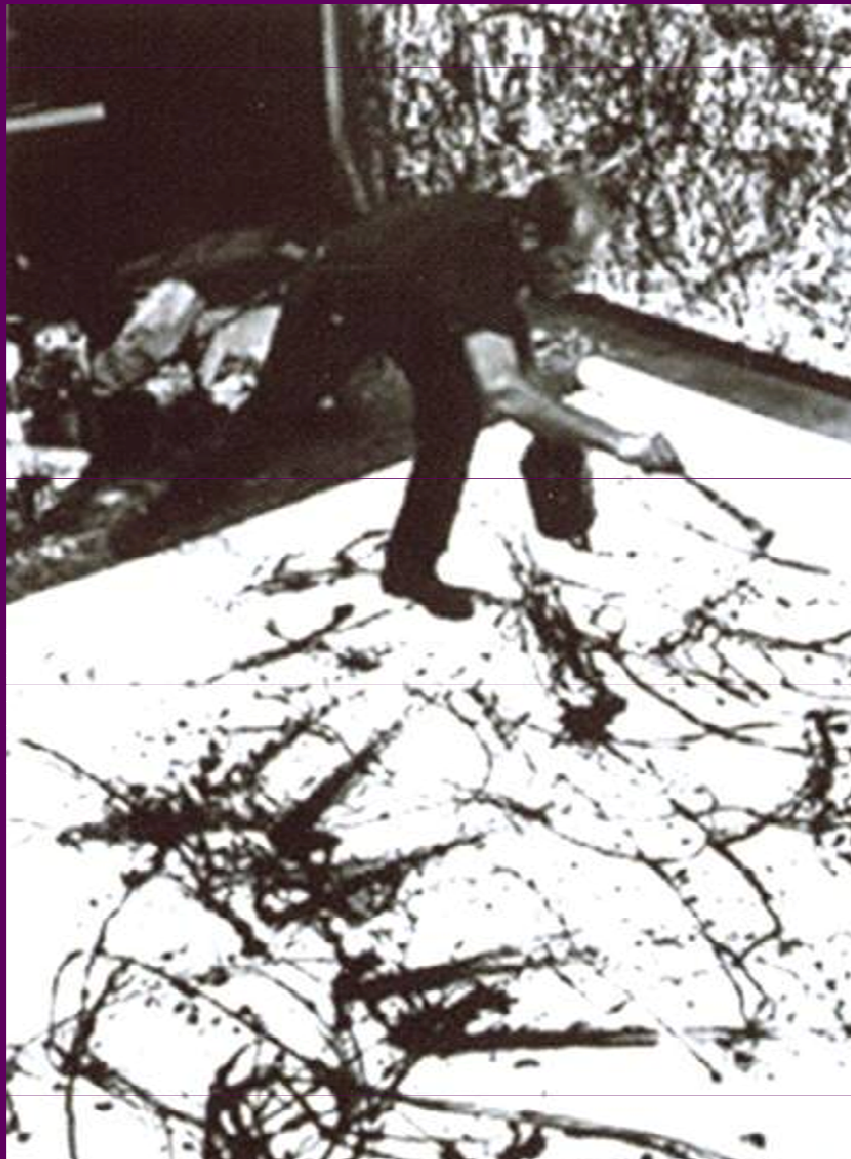

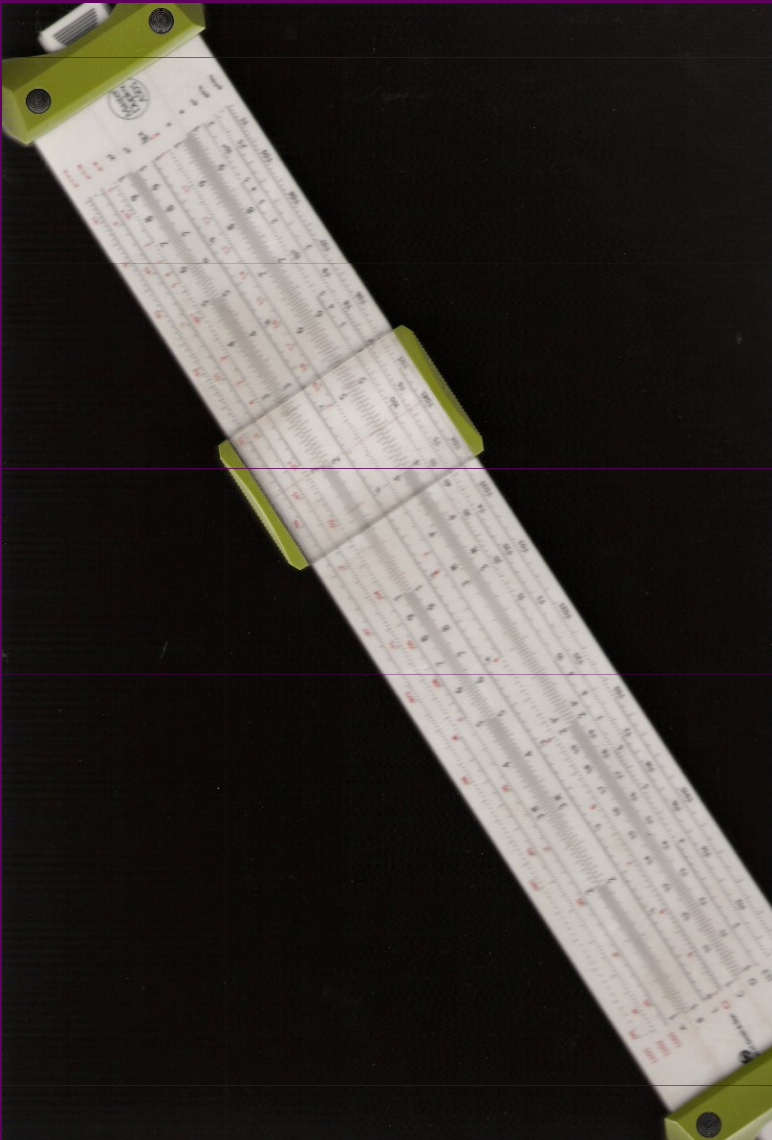

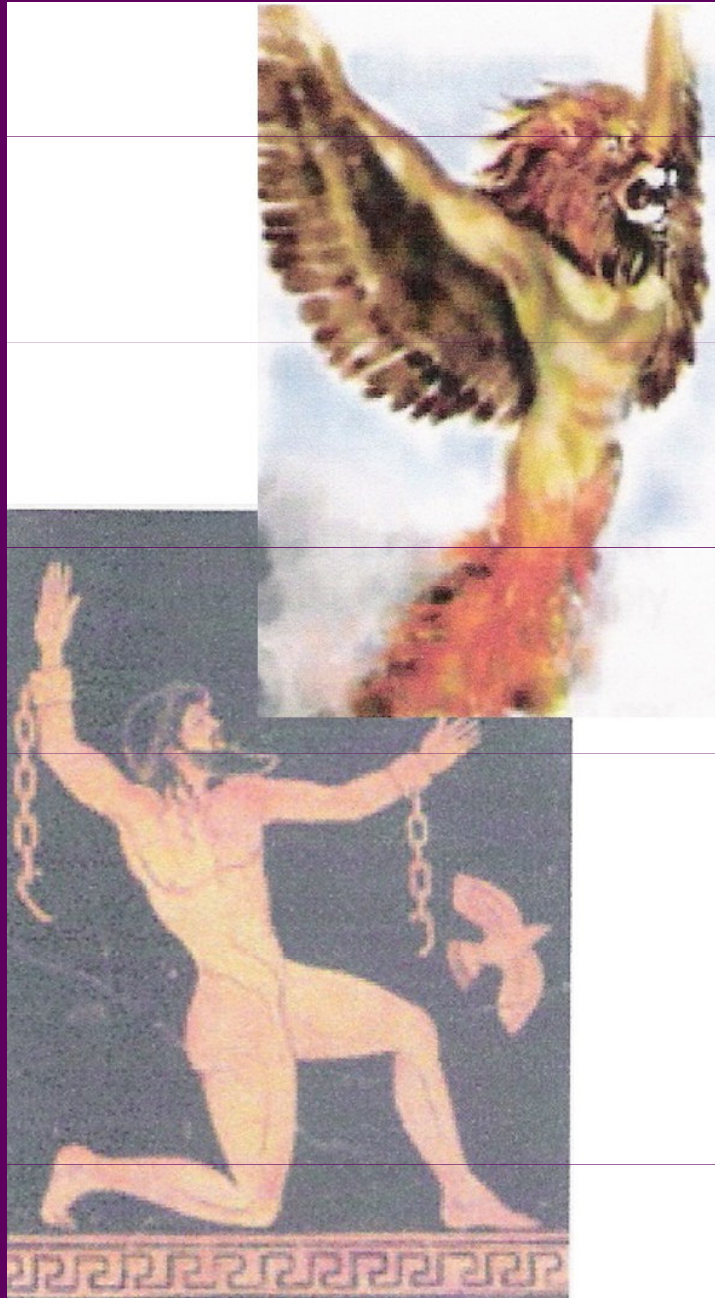

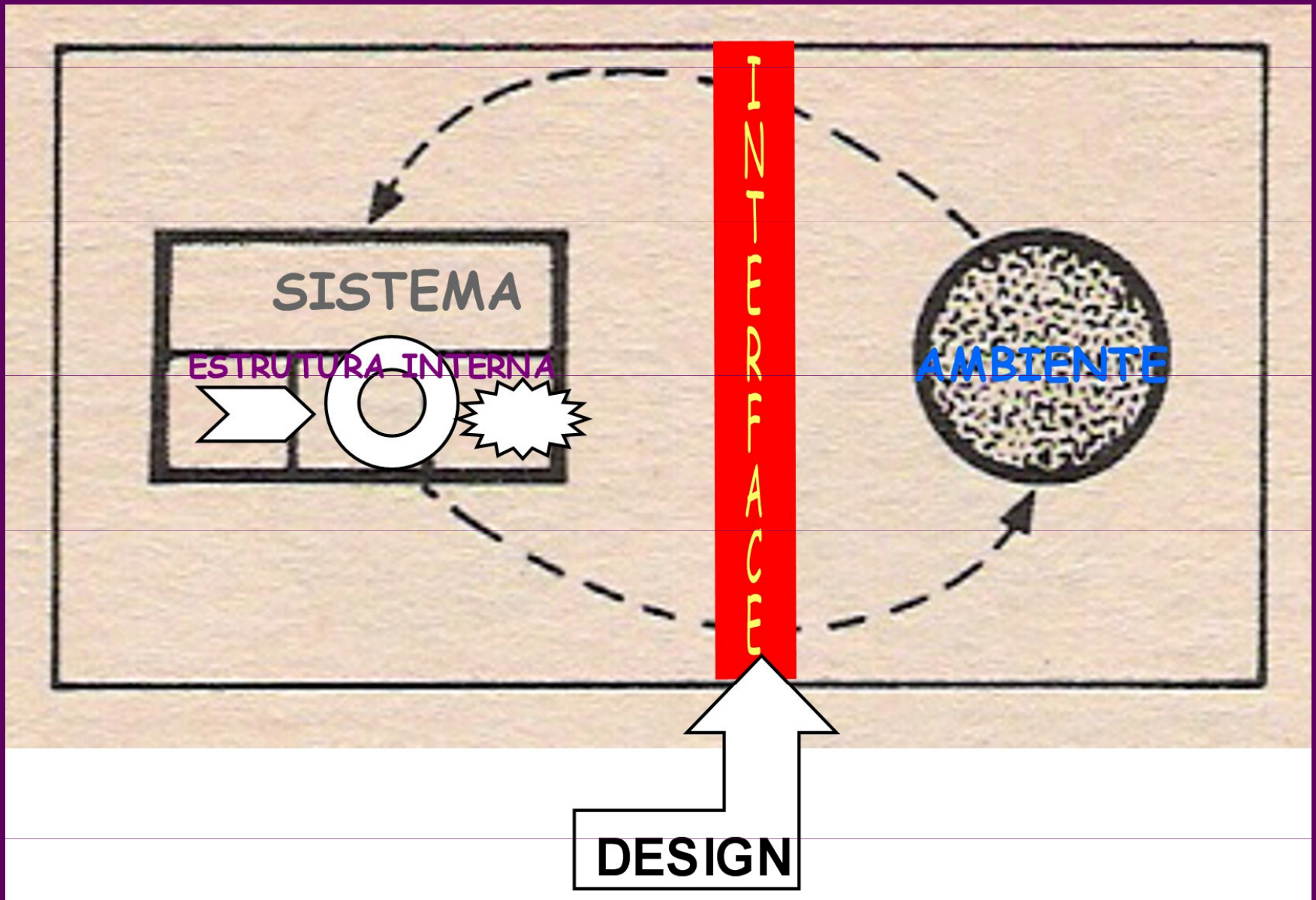





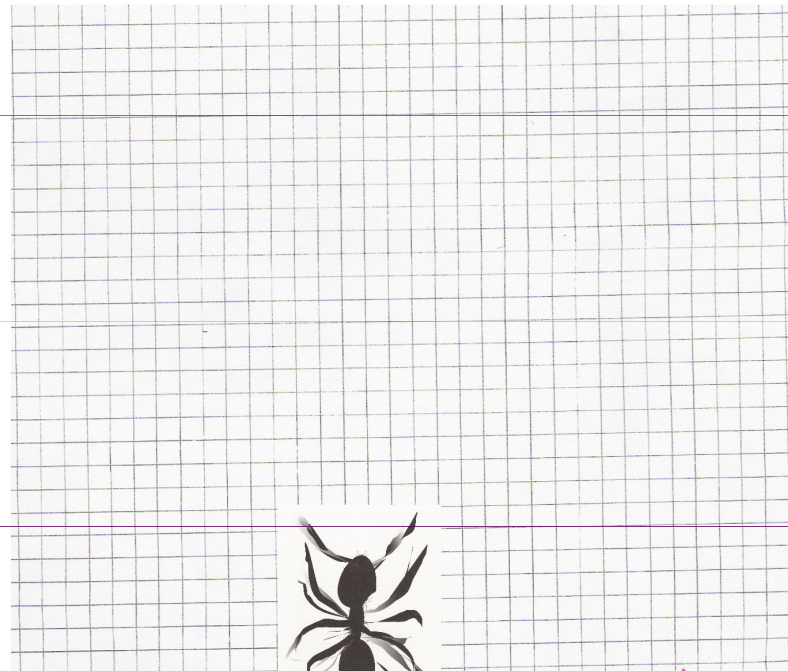

SE ENCONTRA UMA CÉLULA VAZIA,
DEIXA UM SINAL COLORIDO,
E RODA 90° PARA A DIREITA

SE ENCONTRA UMA CÉLULA PREVIAMENTE COLORIDA;
APAGA O SINAL,
E RODA 90° PARA A ESQUERDA

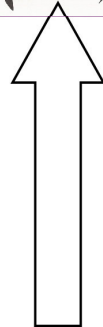

FORMIGA DE LANGTON

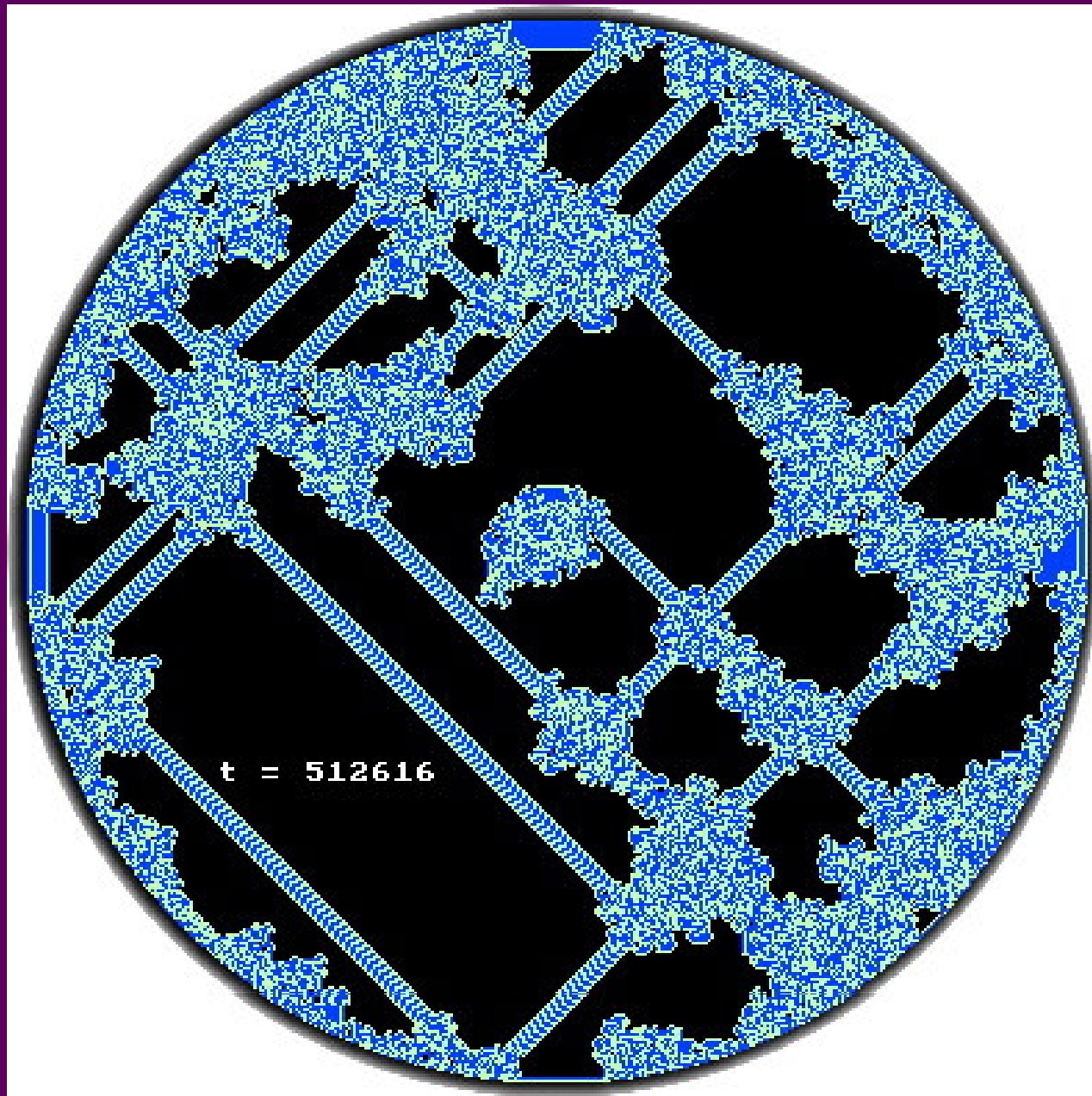

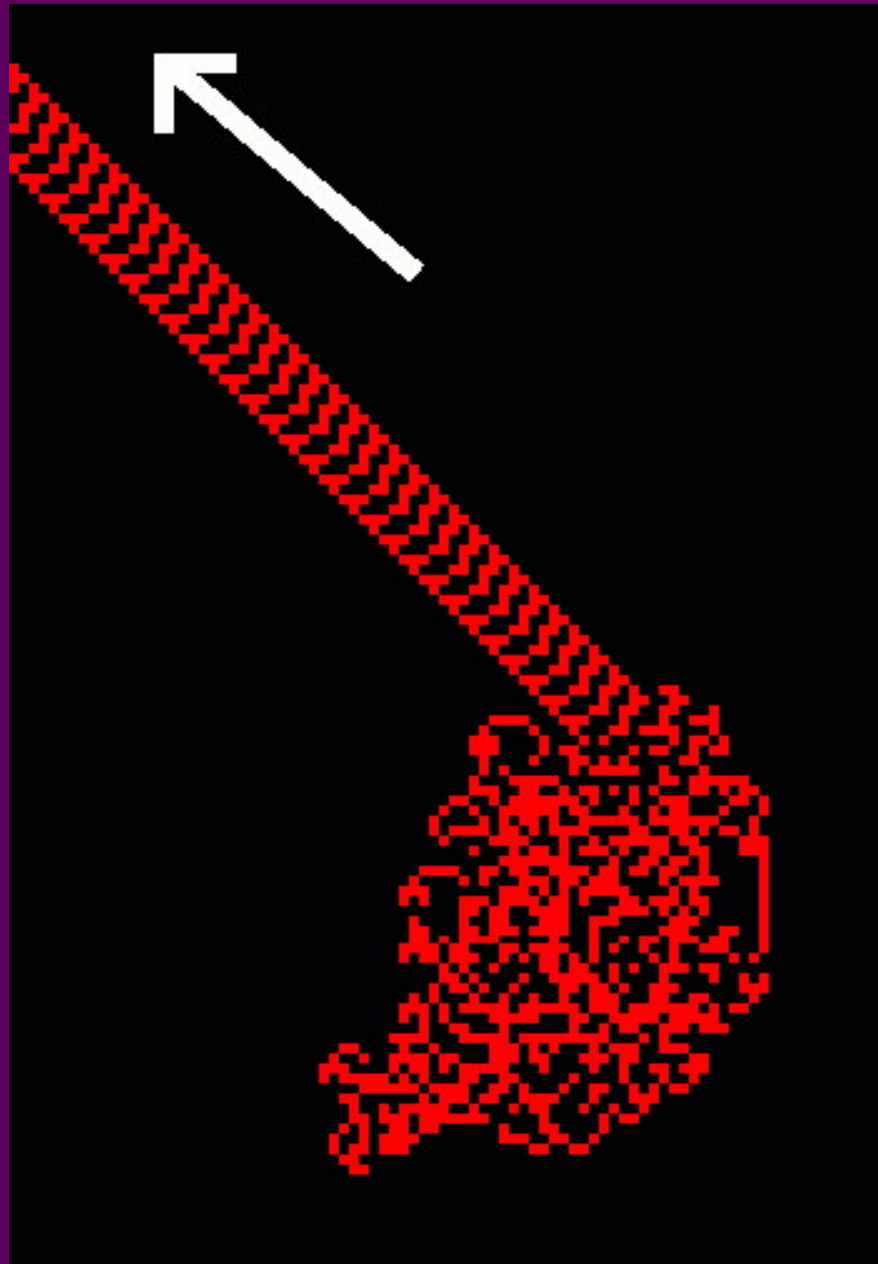

Diferença Radical entre os Fluxos Materiais e Imateriais

JOGO DE SOMA NULA

(Fluxo de massa, energia e capital)

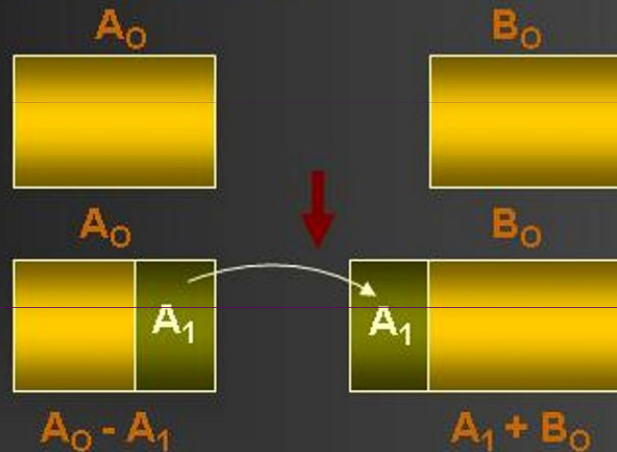

ESTADO INICIAL

$$A_0 + B_0$$

ESTADO FINAL

$$A_0 + B_0$$

JOGO DE SOMA POSITIVA

(Fluxo de informação e conhecimento)

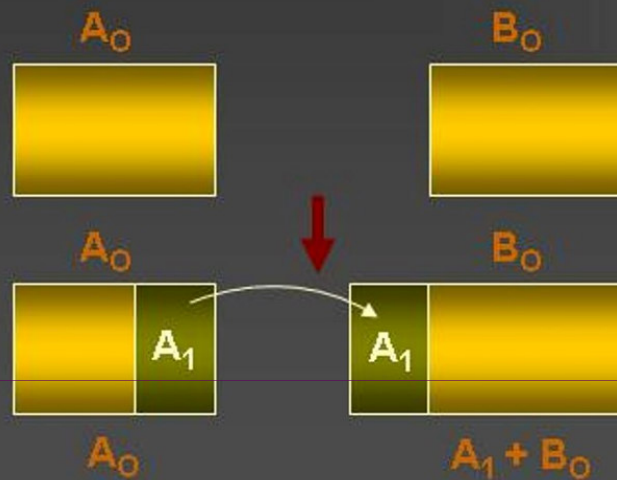

ESTADO INICIAL

$$A_0 + B_0$$

ESTADO FINAL

$$A_0 + B_0 + A_1$$



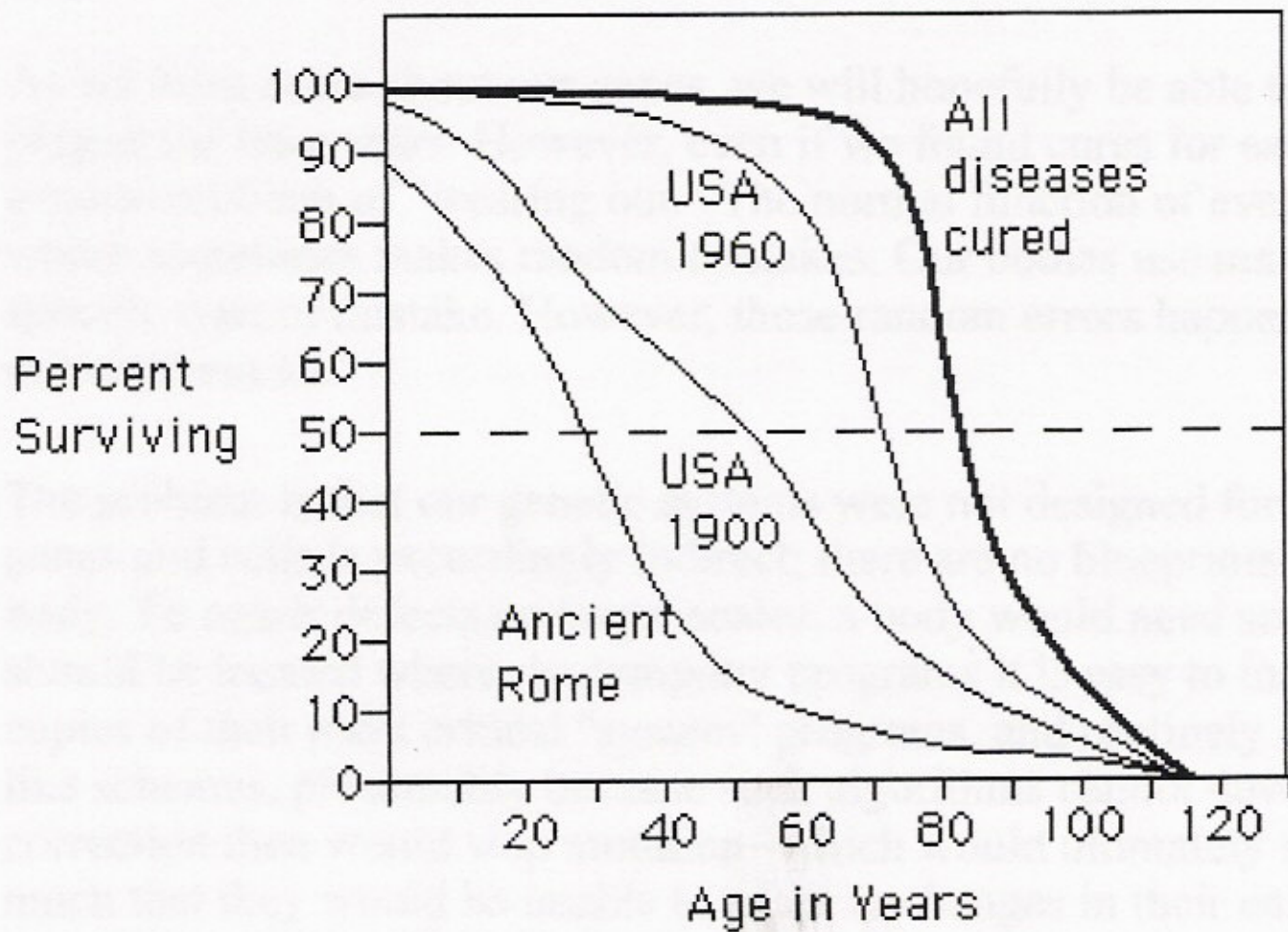



de um ano antes de Pessoa e Sá-Carneiro se decidirem por um movimento autónomo. Em Abril e em Julho de 1915, são publicados dois números da revista *ORPHEU*, que foram o lançamento digamos oficial e polémico do vanguardismo. Um terceiro número ficou em provas por dificuldades várias. Aqueles dois números produziram, nos meios intelectuais e jornalísticos, precisamente o efeito que os promotores desejavam. Conta-se que, estando Sá-Carneiro já no expresso em que partia para uma das suas idas a Paris, chegou Pessoa correndo com um jornal na mão, em que um ilustre psiquiatra da época, que havia sido entrevistado sobre «os do *ORPHEU*», gravemente os declarava doidos. Pessoa gritava: – O Júlio de Matos diz que somos doidos! – E Sá-Carneiro, debruçado na janela do comboio em andamento, e arrebatando o jornal, exclamou: – Ah diz? Então vencemos!

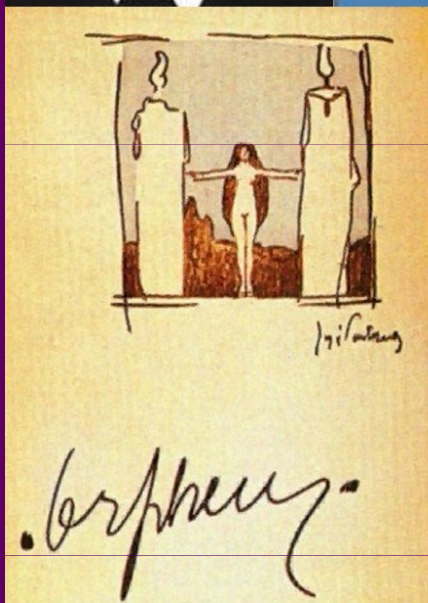

LOUCURA...

MÁRIO DE SÁ-CARNEIRO





E TER UMA TRABALHEIRA?!?
NÃO, VAMOS INVENTAR UM ROBÔ QUE FAÇA A CAMA POR NÓS!



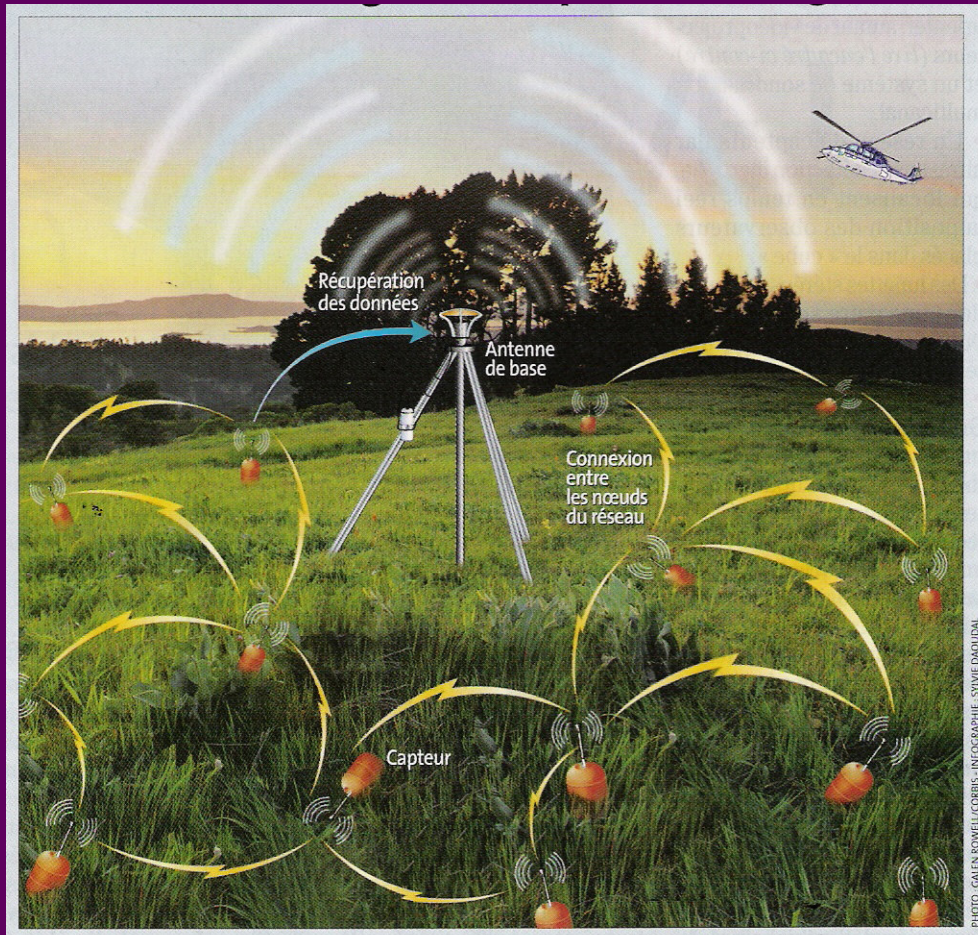



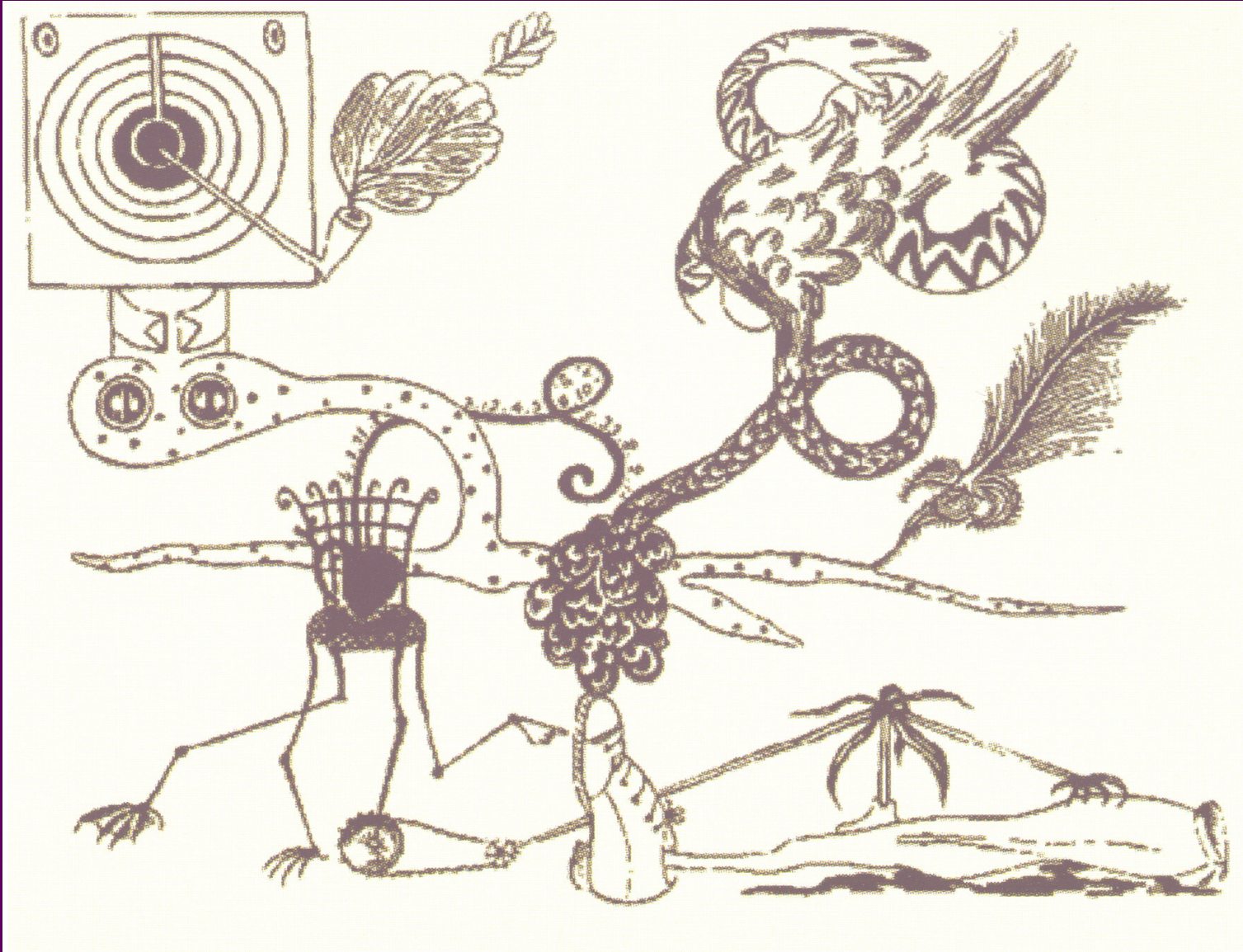

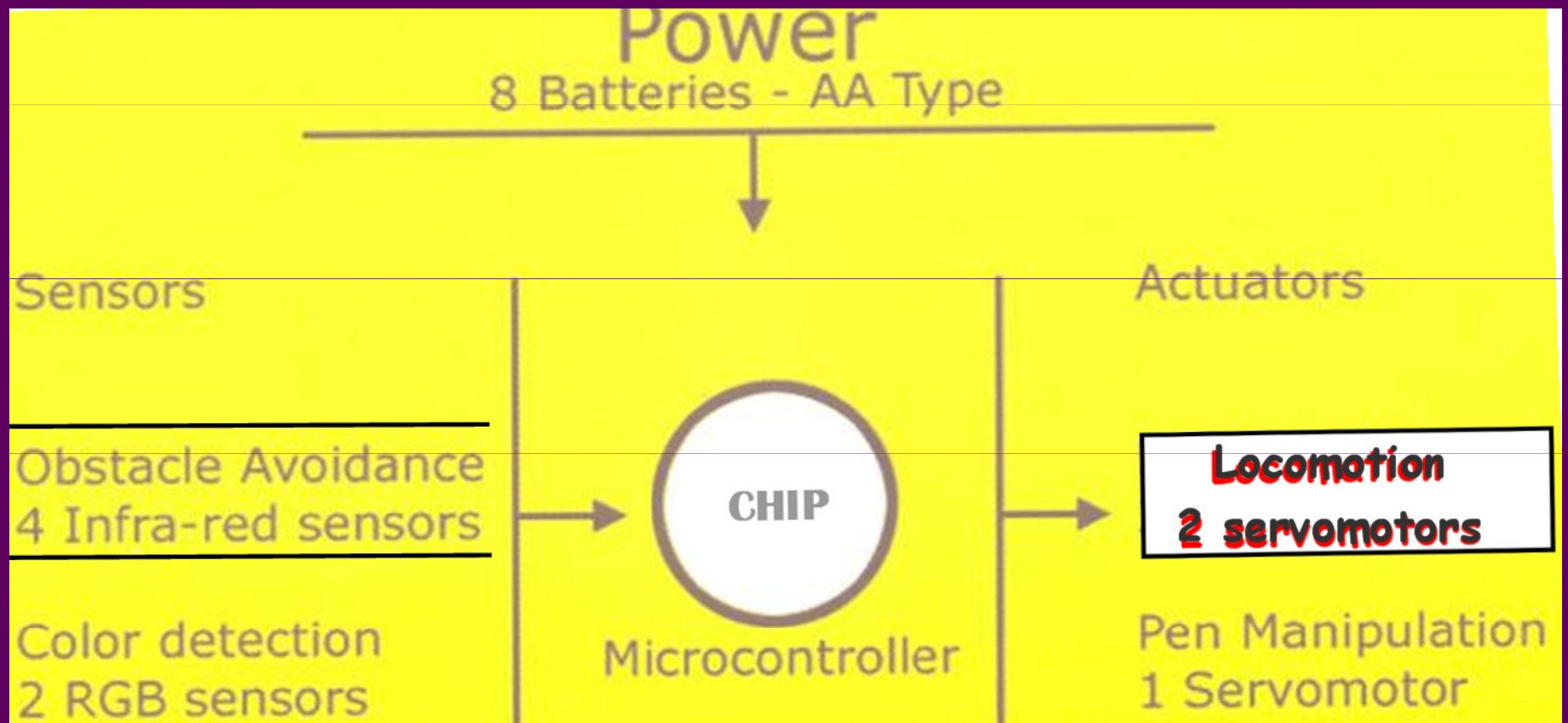

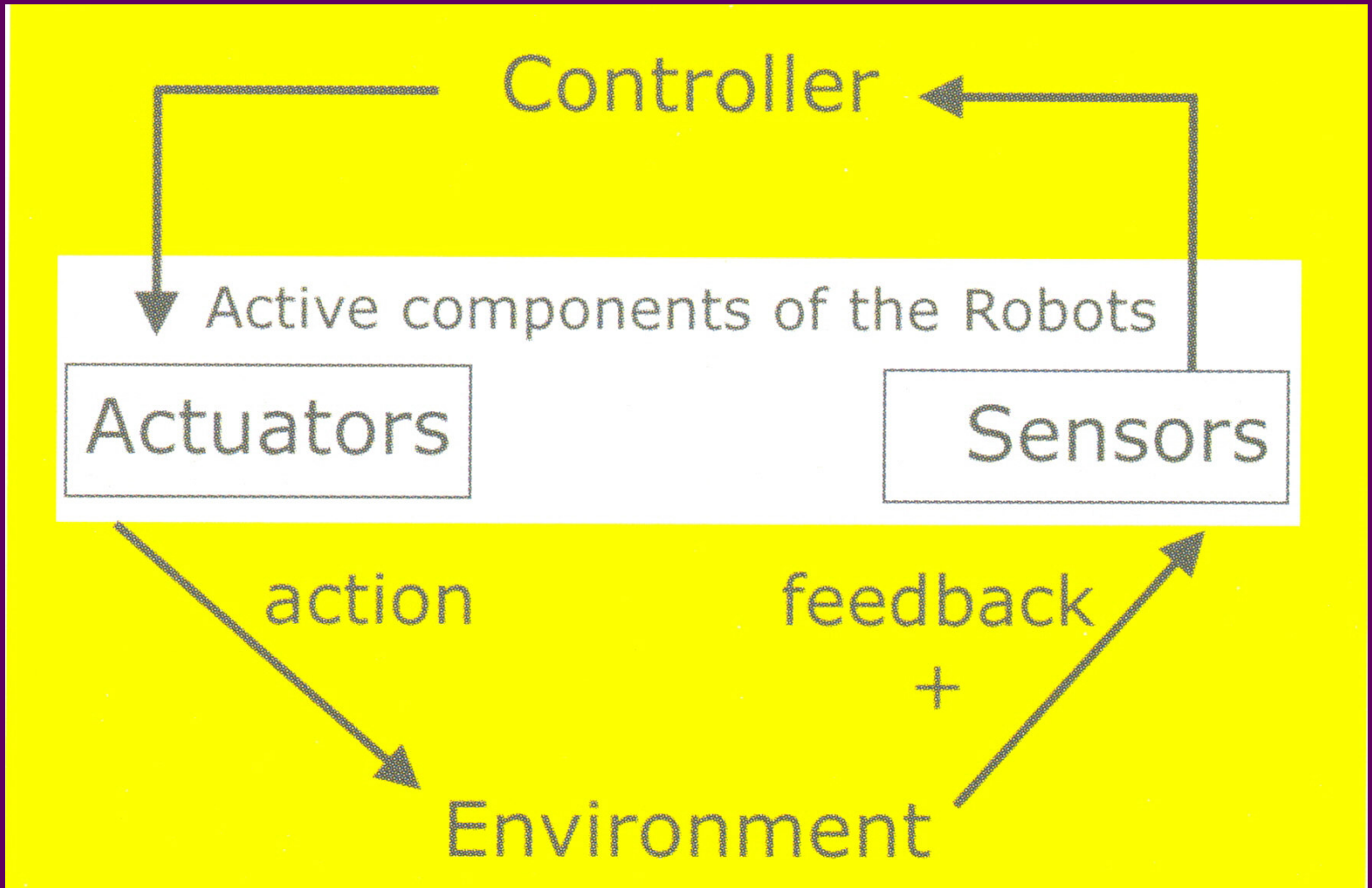

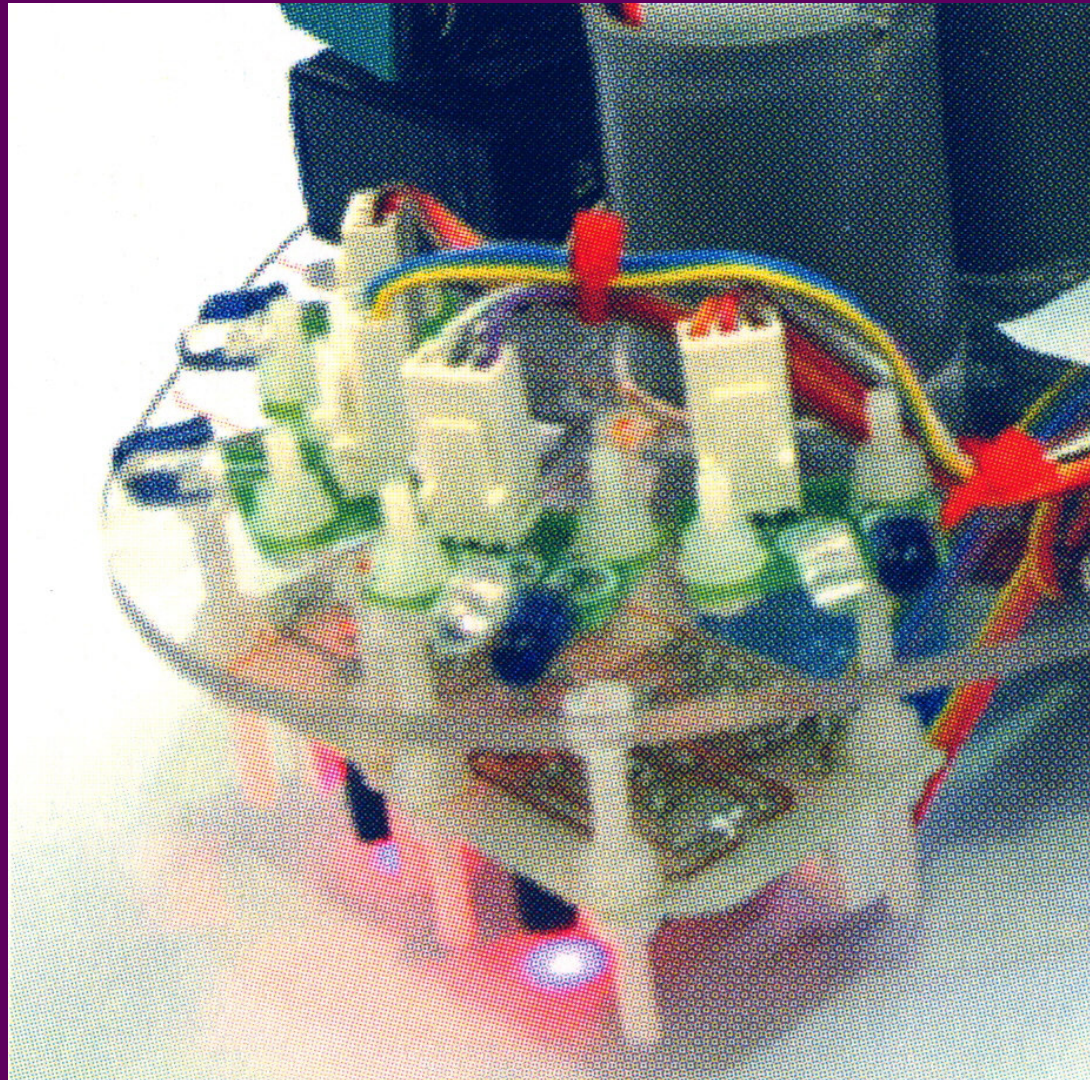

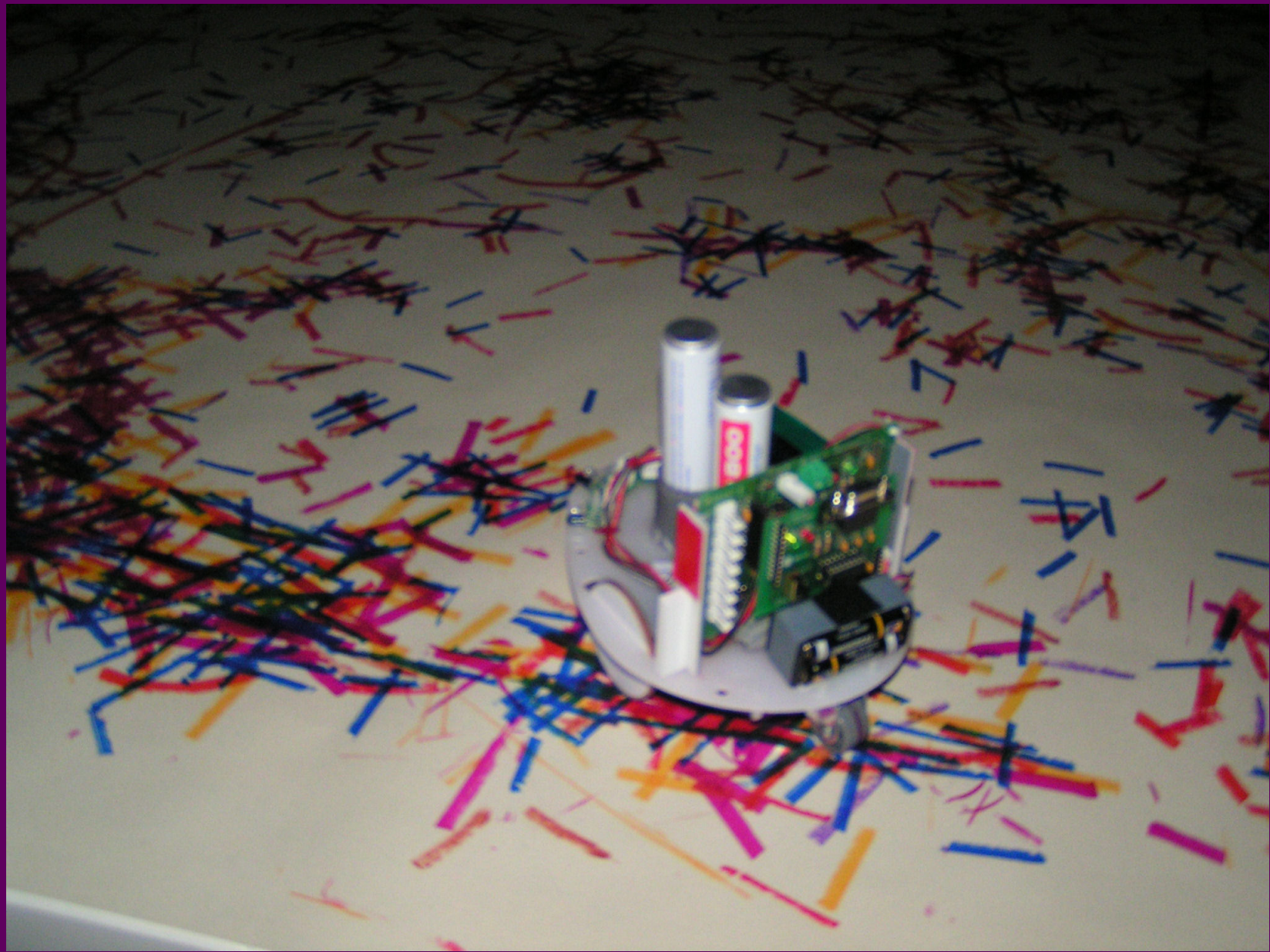





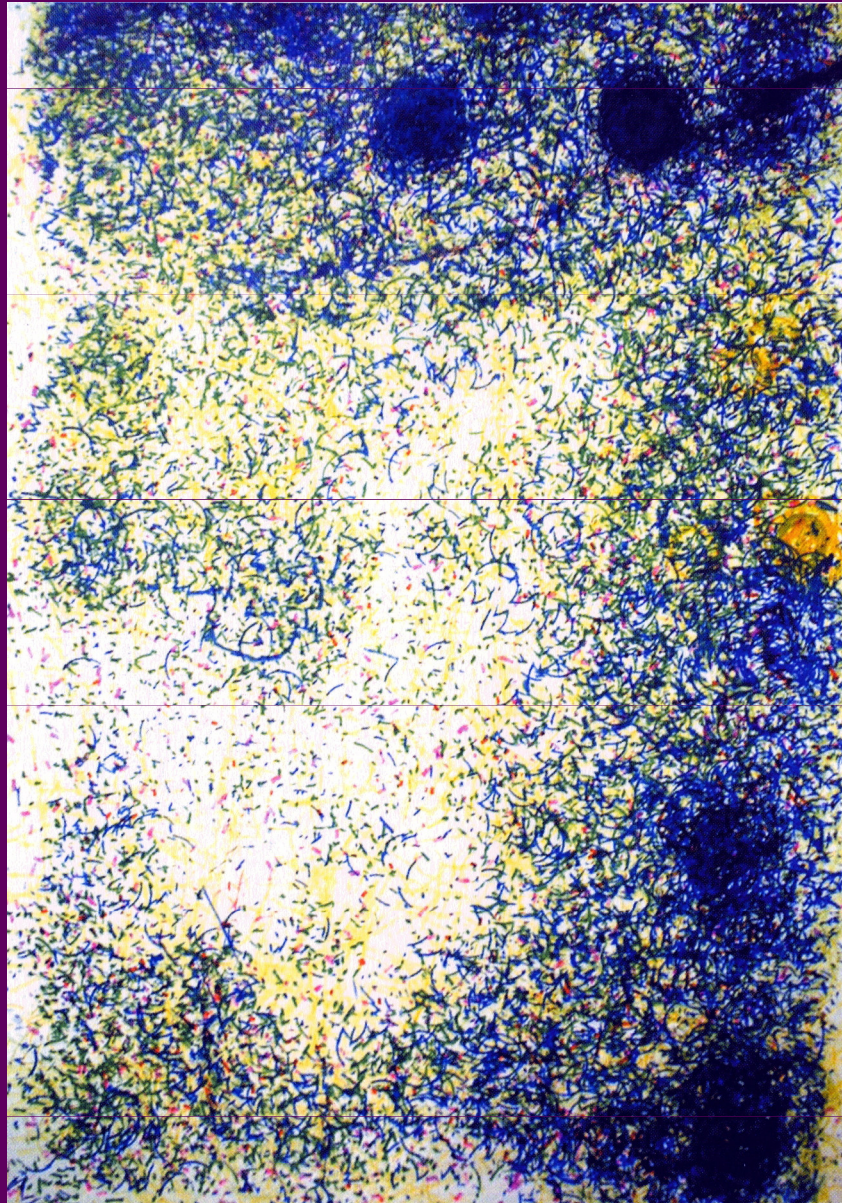

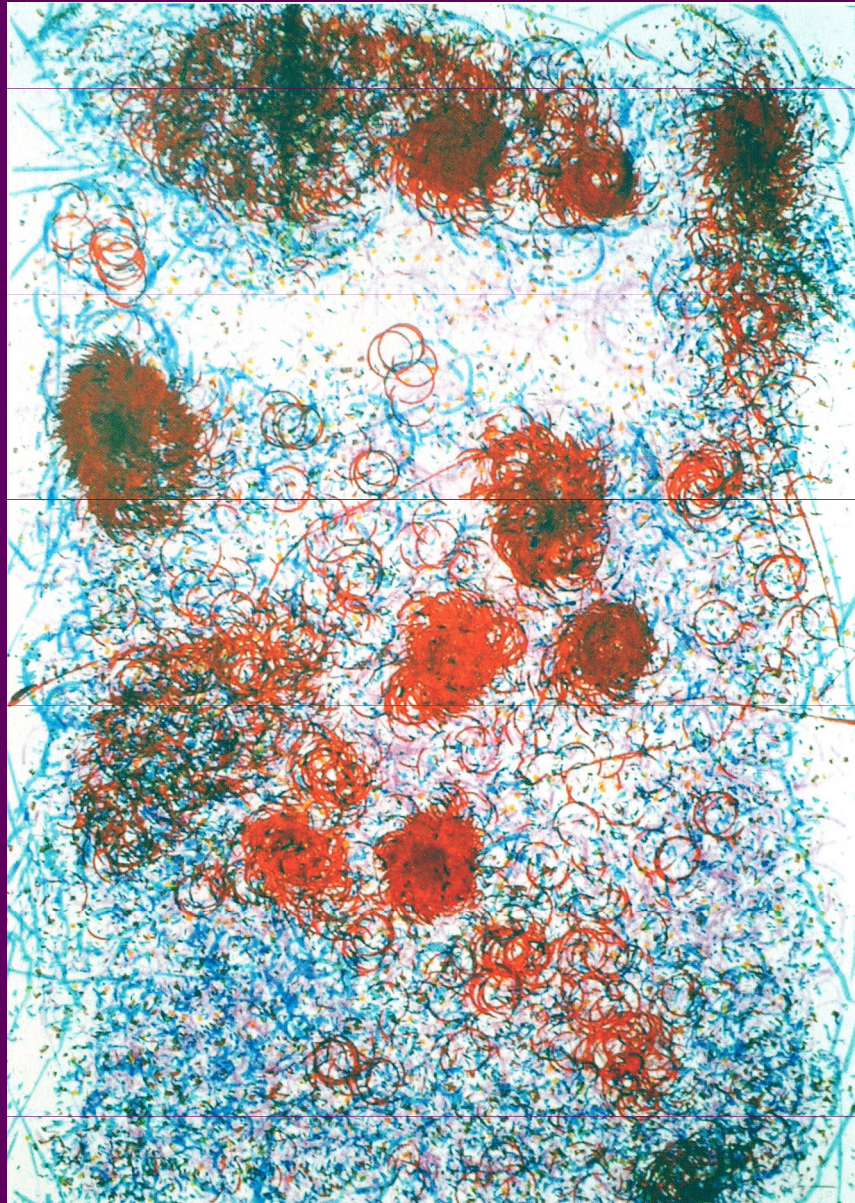

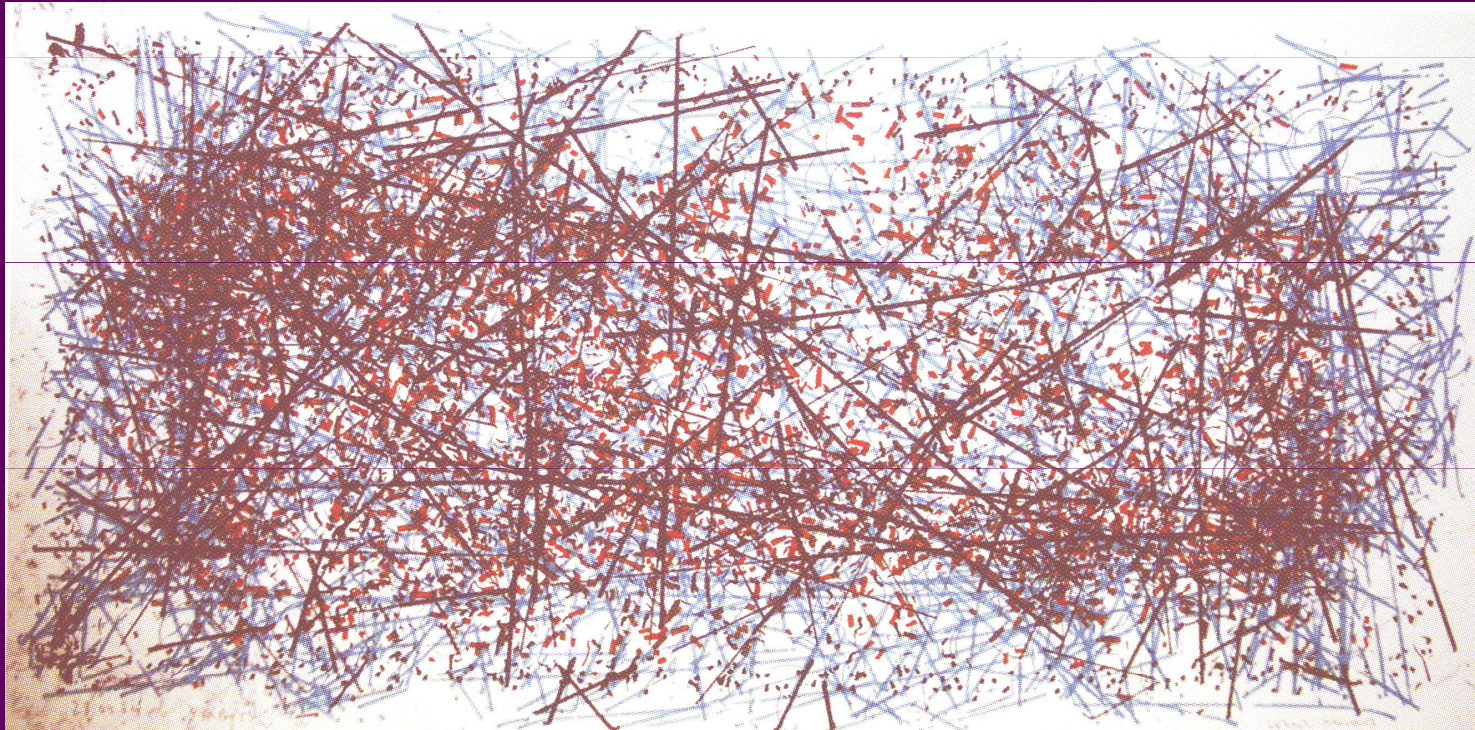

FINAL ŒUVRE

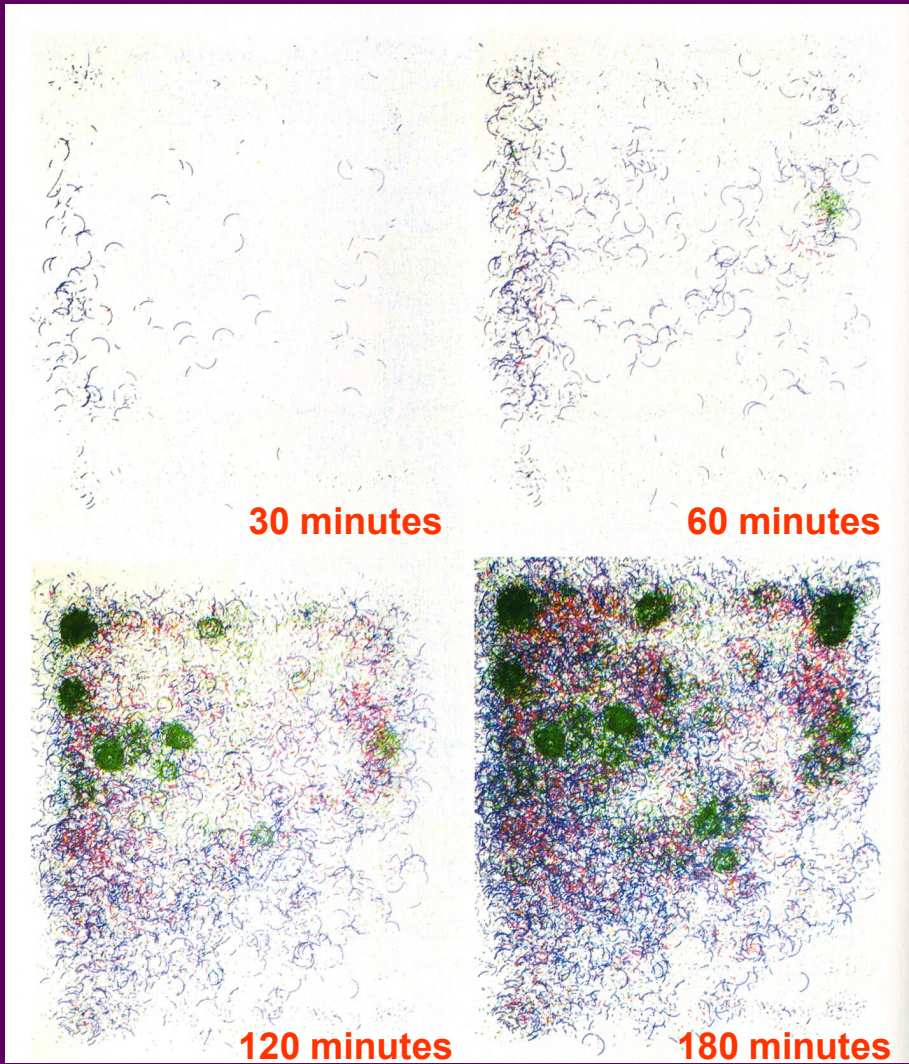

PAINTING IN PROGRESS



TURING TEST

